

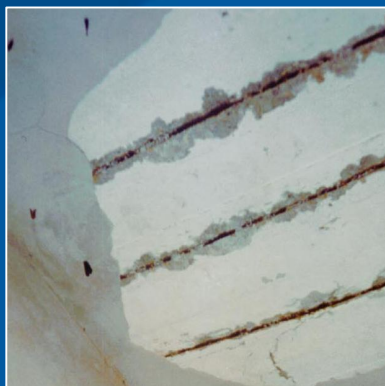

SCHOMBURG

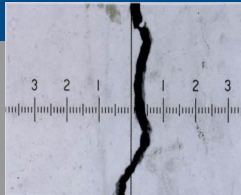

SCHOMBURG



CM-

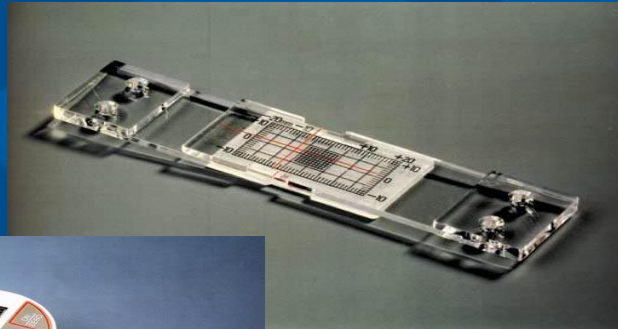

SCHOMBURG



Aquafin-P1, Aquafin -P4



DUROSEAL Injekt 2060, 215
DUROSEAL Multigel 850



SCHOMBURG

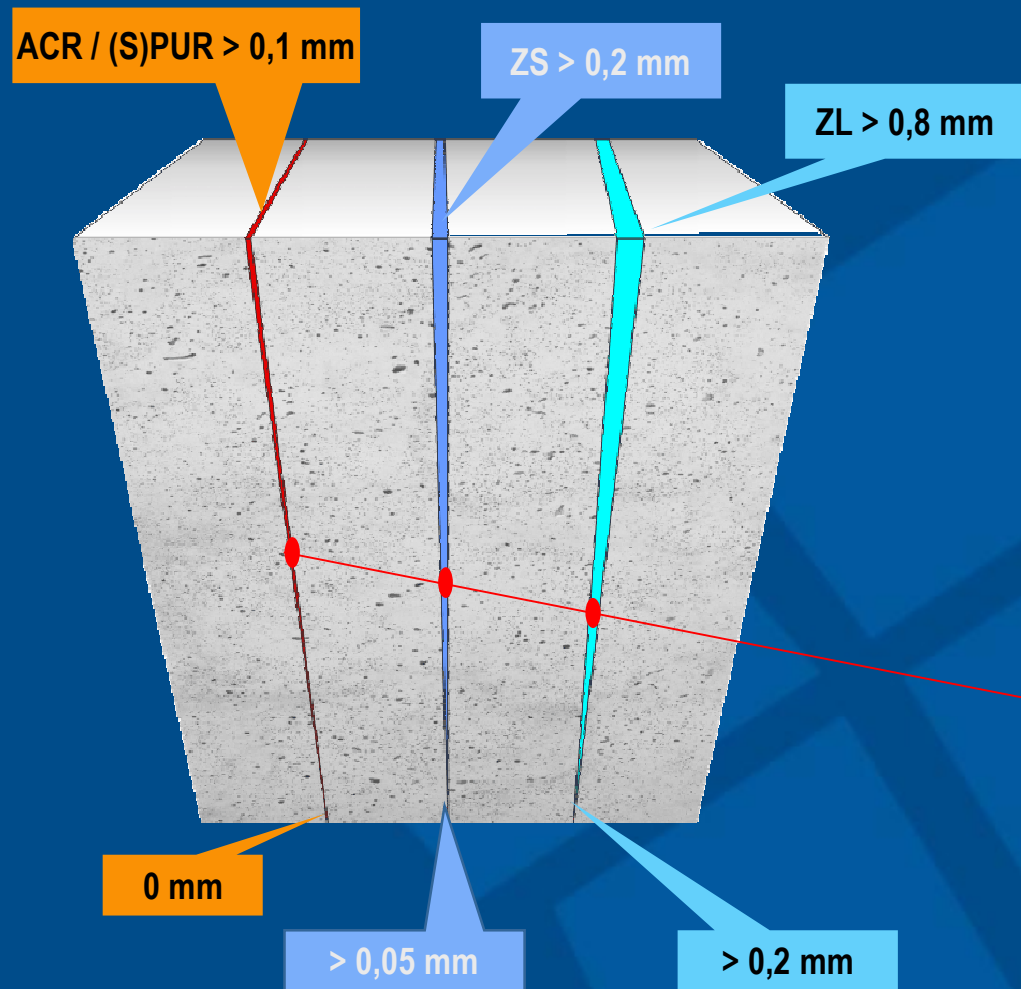

ACR =
(S)PUR = ()

ZS =

ZL =

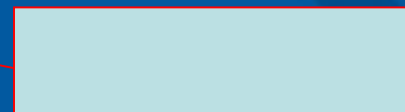

WWW.ELITSTROY.SU
8-926-535-39-36
r-mobin@ya.ru

SCHOMBURG

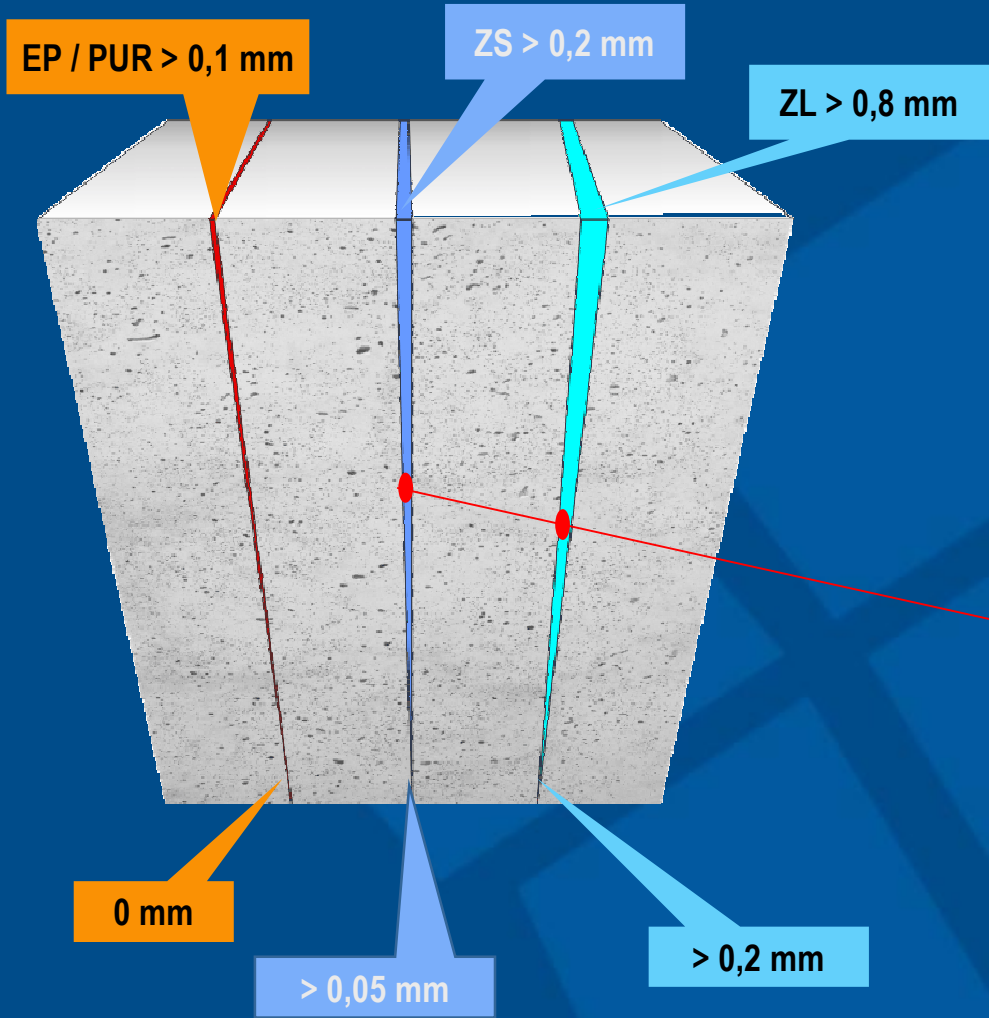

EP =
PUR =
ZS =
ZL =



SCHOMBURG

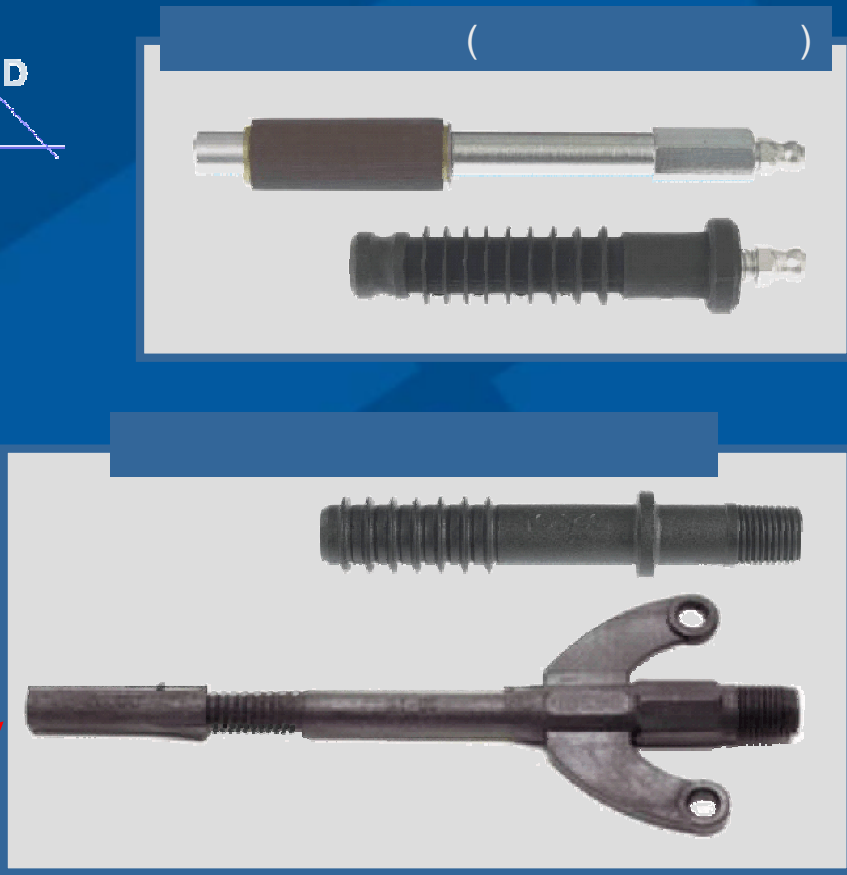
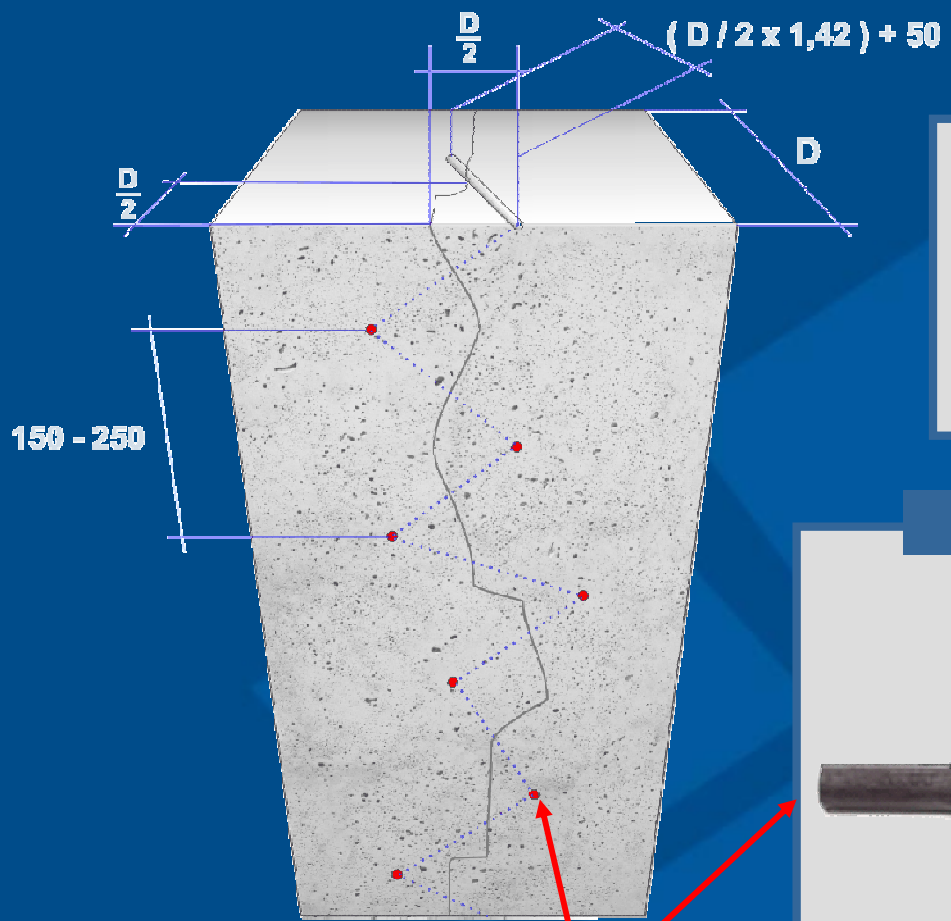

SCHOMBURG

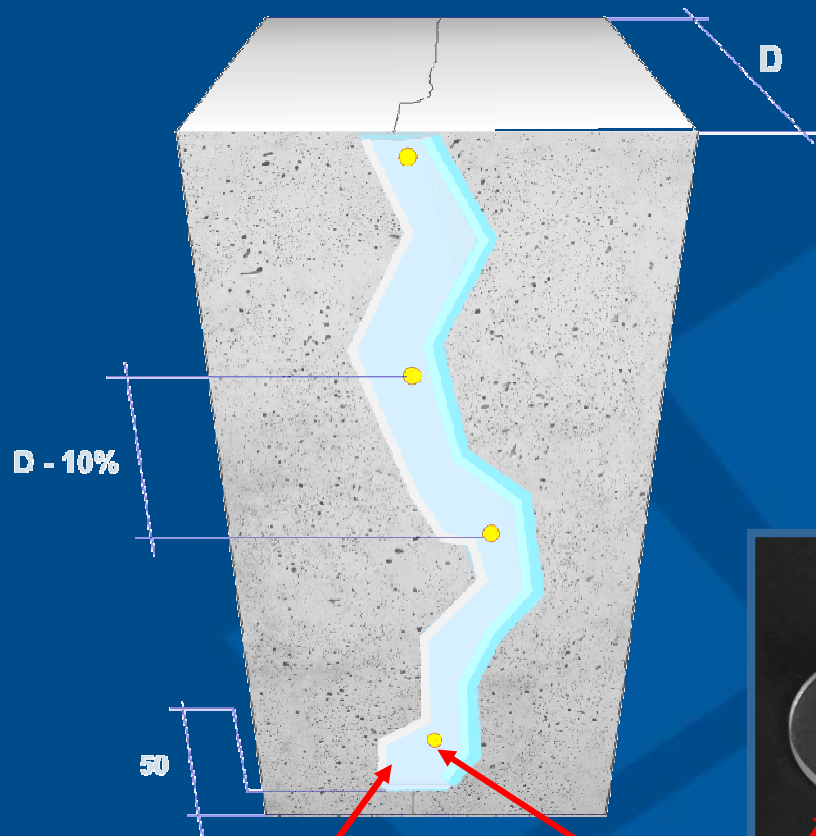

Asodur-EK98-Wand



Steinklebeband

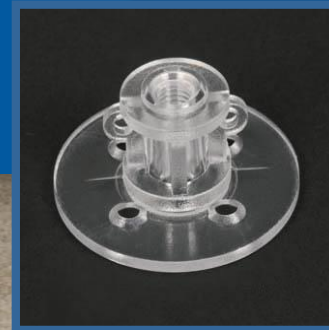

SCHOMBURG

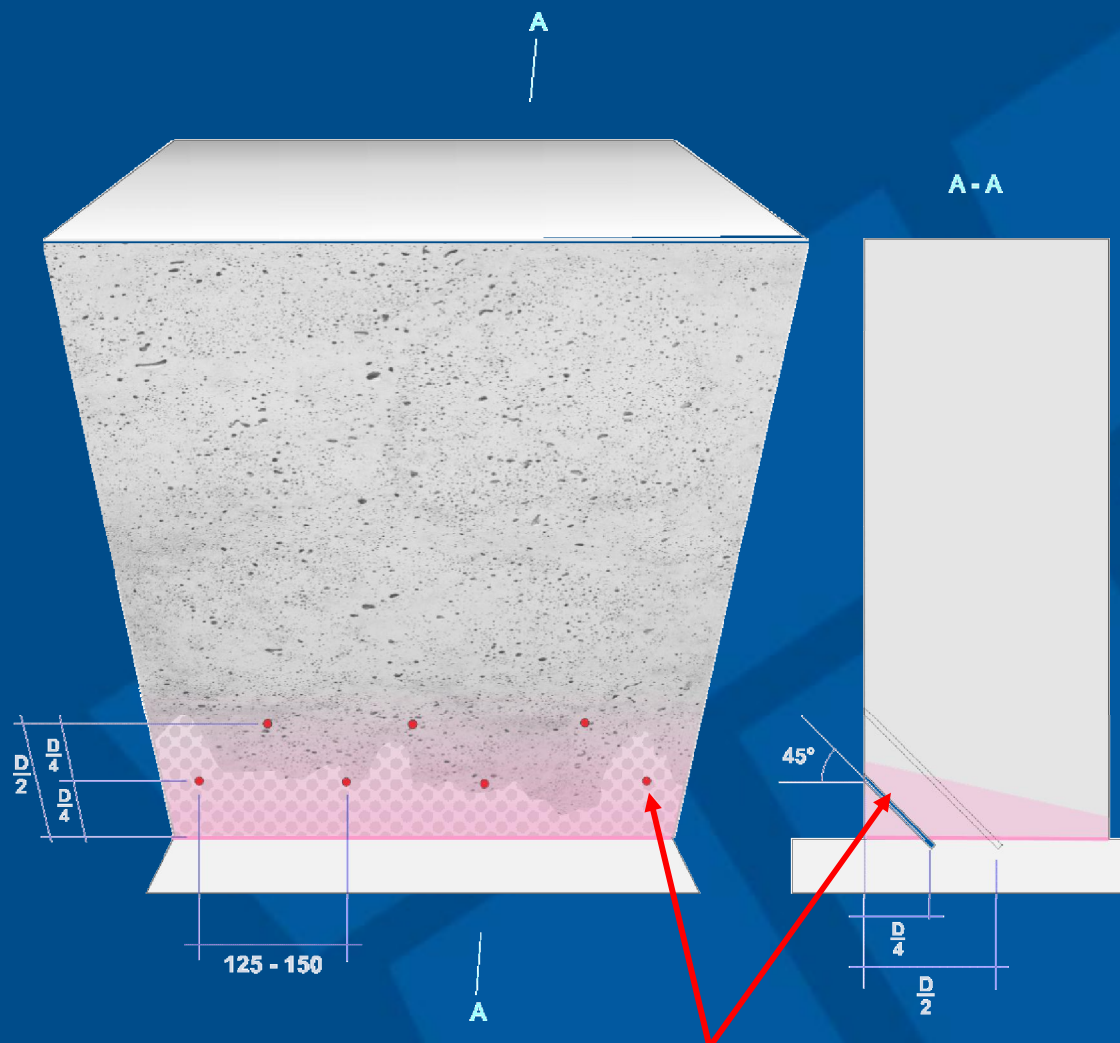

SCHOMBURG

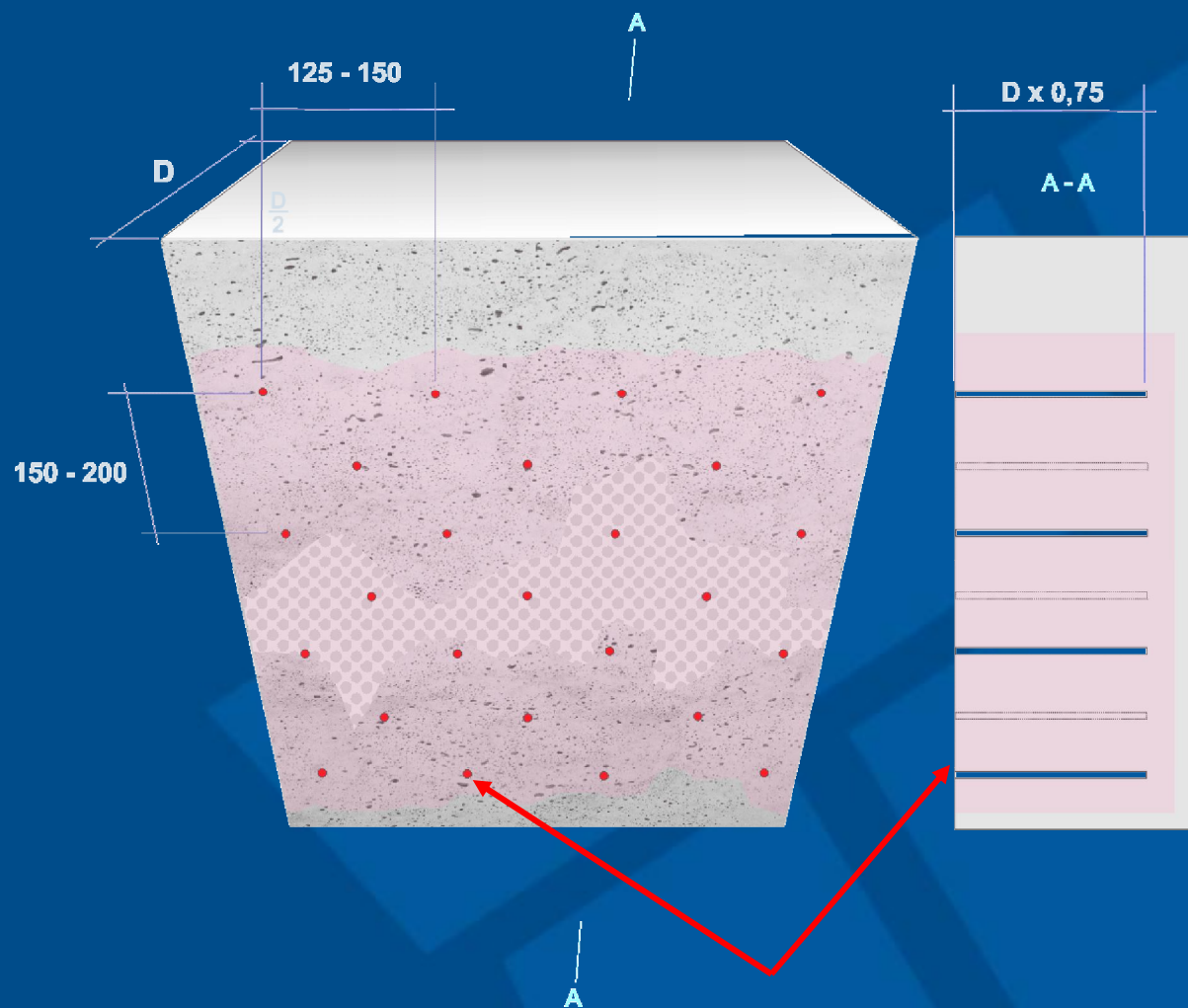

SCHOMBURG



SCHOMBURG

1 -

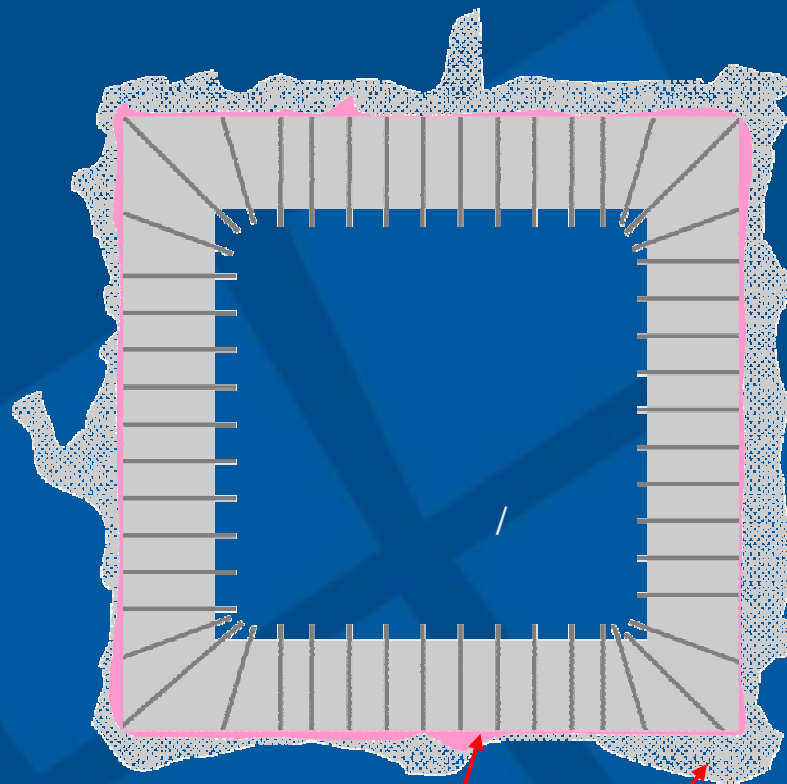
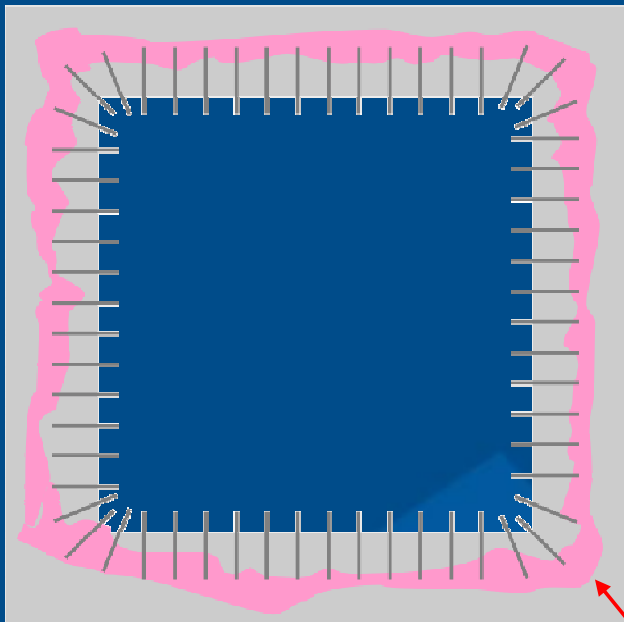

SCHOMBURG

WWW.ELITSTROY.SU
8-926-535-39-36
r-mobin@ya.ru



(

) Multigel 850

Duro-Soil





DESOI SP-Y



DESOI Kompakt PN-1412

SCHOMBURG

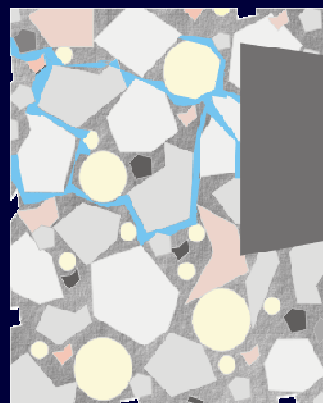

FIX 10-S

FIX 10-S

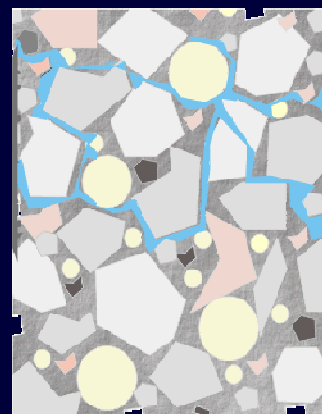

SCHOMBURG

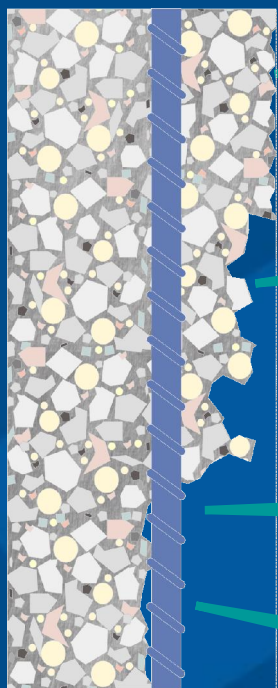

2 $\ddot{E}5$

5 $\ddot{E}25$

> 25

SCHOMBURG



(/) -

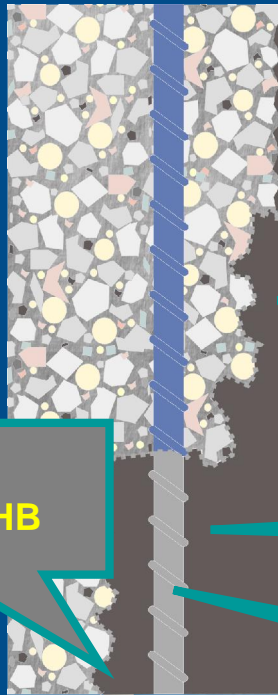

Asocret-FS, Asocret-BS2

Asocret-RN

Asocret-KS/HB

Asocret-FM40/V

Asocret-KS/HB

SCHOMBURG

(/)-

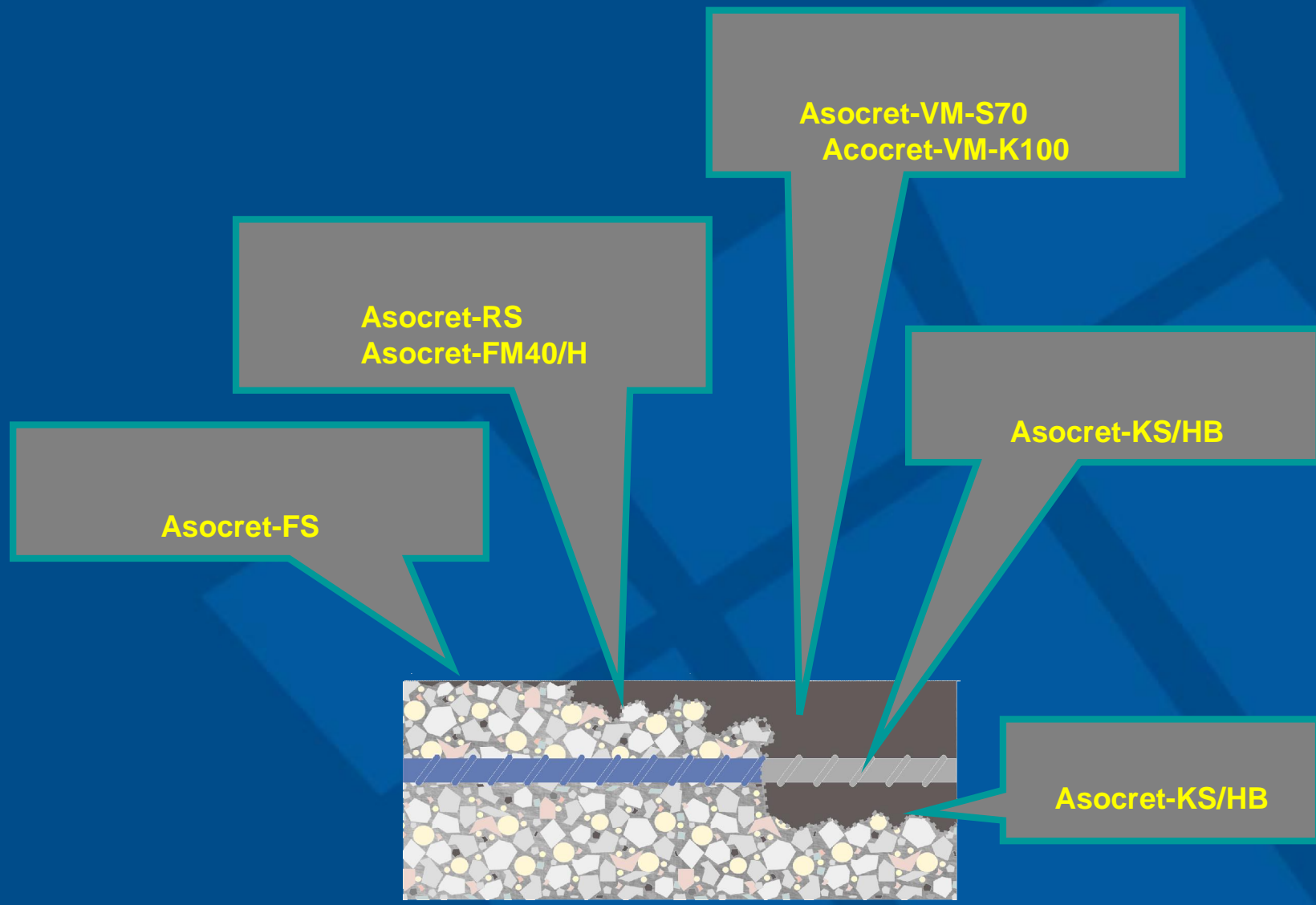

SCHOMBURG



,

0

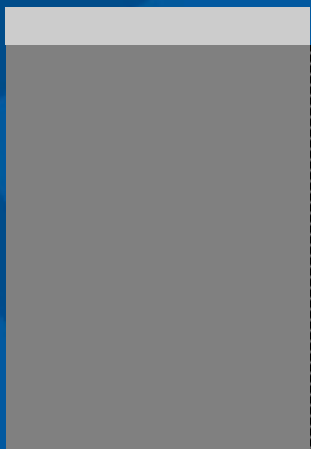

SCHOMBURG

Ä AQUAFIN-1K



1 + 1 + 1



1

:

1 + 1



SCHOMBURG

Ä ASODUR-SG2



1 + 1

SCHOMBURG



1,6

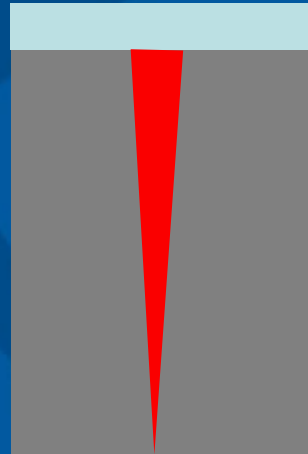

/

SCHOMBURG

Ä AQUAFIN-2K



1 + 1 + 1

SCHOMBURG

Ä AQUAFIN-2K/M



1 + 1 + 1



1 + 1



SCHOMBURG